

Delence

Recinzioni



Square 40 EVO



Specifiche:

DF-8605N

Colonna 40x40mm

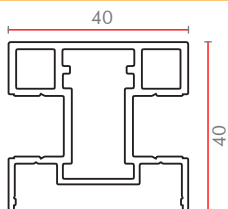

DF-8604C

Cover per colonna 40x40mm



DF-8004

Cover per colonna 40x40mm

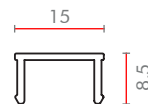

DF-8006

Doga anodizzata 100x14mm (5,30kg)

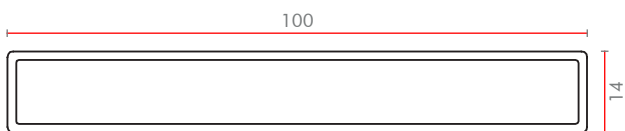

DF-8006A

Doga 100x14mm (4,80kg)

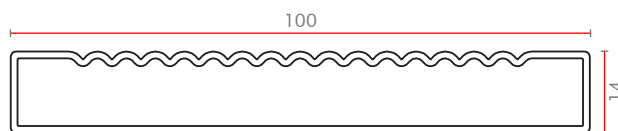

DF-7036ASP

Cover decorativa per base
40x40mm



DF-7036L

Barra di supporto per colonna



DF-7013S

Tappo terminale per colonna
40x40mm



Square 60 H

Specifiche:

DF-8005AN

Colonna 60x60mm

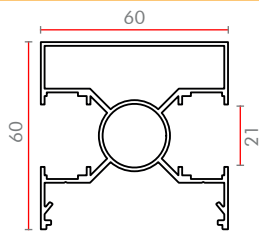

DF-8004C

Cover per colonna 60x60mm



DF-8003

Cover per colonna 60x60mm



DF-8006B

Doga 150x14mm (8,10kg)

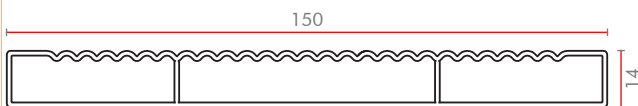

DF-6010

Profilo 11x30mm

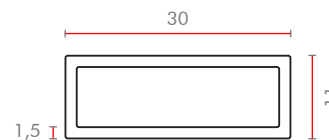

DF-8002N

Flangia per colonna 60x60mm



DF-5003M

Supporto a pavimento per colonna
(45cm)



DF-8013A

Tappo terminale per colonna
60x60mm



Square 60 V



Specifiche:

DF-8005AN
Colonna 60x60mm

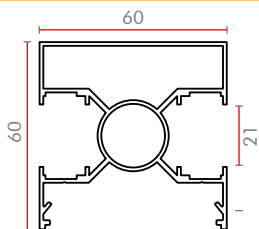

DF-8004C
Cover per colonna 60x60mm



DF-8003
Cover per colonna 60x60mm



DF-8006A
Doga 100x14mm (4,80kg)

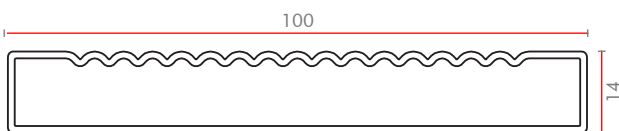

DF-8006D
Traversa per sistema
verticale 60x14mm (3,90kg)

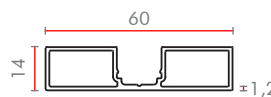

DF-8006K
Cover per traversa
DF-8006D (0,50kg)

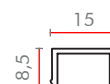

DF-8013A
Tappo terminale per colonna
60x60mm



DF-8009
Tappo terminale per colonna
100x14mm



DF-8002N
Flangia per colonna 60x60mm



Profili

DF-8005AN

Colonna 60x60mm

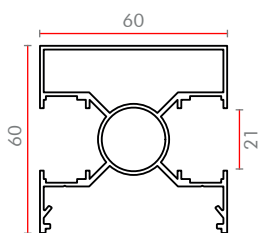

AND
ANT
SAB
8017
WCC
WCM
WCS

DF-8004C

Cover per colonna 60x60mm



AND
ANT
SAB
8017
WCC
WCM
WCS

DF-8003

Cover/riduttore per colonna 60x60mm



AND
ANT
SAB
8017
WCC
WCM
WCS

DF-8005C

Colonna angolare 60x60mm

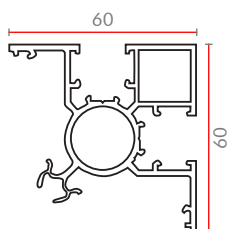

AND
ANT
SAB
8017
WCC
WCM
WCS

DF-8004J

Cover per colonna 60x60mm

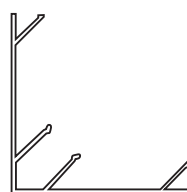

AND
ANT
SAB
8017
WCC
WCM
WCS

DF-8006

Doga anodizzata 100x14mm (5,30kg)

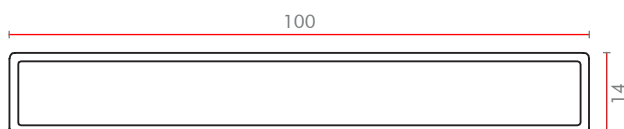

AND

DF-8006A

Doga 100x14mm (4,80kg)

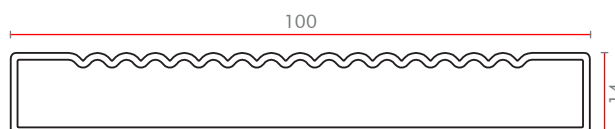

ANT SAB 8017 WCC WCM WCS

DF-8006B

Doga 150x14mm (8,10kg)

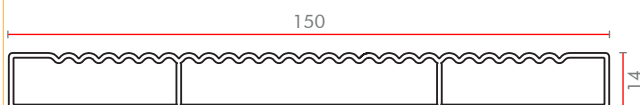

ANT SAB 8017 WCC WCM WCS

DF-8006C

Doga perlinata 130x14mm

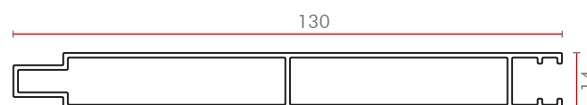

ANT SAB 8017

DF-8006P

Doga 140x14mm

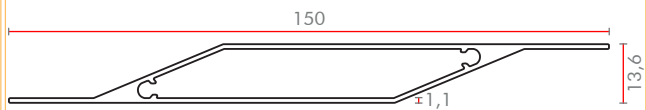

ANT SAB 8017

DF-6010

Profilo 11x30mm

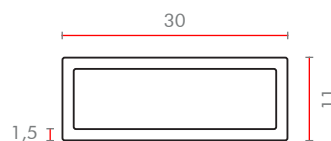

AND

DF-8006D

Traversa per sistema verticale
60x14mm (3,90kg)

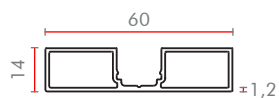

AND
ANT
8017

DF-8006K

Cover per traversa DF-8006D
(0,50kg)



AND
ANT
8017

DF-8605N

Colonna 40x40mm

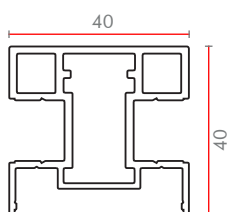

AND

DF-8604C

Cover per colonna 40x40mm

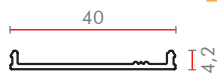

AND

DF-8004

Cover per colonna 40x40mm

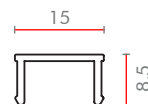

AND

DF-6014

Colonna (10,90kg)

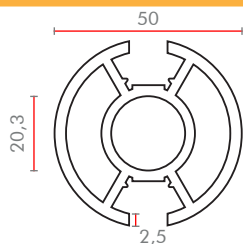

AND

DF-6015

Cover per colonna DF-6014 (0,70kg)

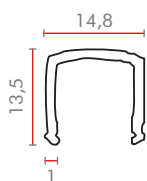

AND

Horizontal Line

M-4482

Design con colonna 40x40mm, profilo 100x14mm e decorativo inox 14x14mm



M-4483

Design con colonna 40x40mm, profilo 100x14mm e decorativo inox 30x11mm



E-6482

Design con colonna 60x60mm, profilo 100x14mm e decorativo inox 14x14mm



E-6492

Design con colonna 60x60mm, profilo 150x14mm e decorativo inox 14x14mm



E-6484

Design con colonna 60x60mm, profilo 100x14mm e decorativo inox 100x14mm



M-4493

Design con colonna 40x40mm, profilo 150x14mm e decorativo inox 30x11mm



Vertical & Vertical Line

E-6494

Design con colonna 60x60mm, profilo 150x14mm e decorativo inox 100x14mm



C-6491_D

Design con colonna 60x60mm, profilo 150x14mm e doppio colore



E-6483

Design con colonna 60x60mm, profilo 100x14mm e decorativo inox 30x11mm

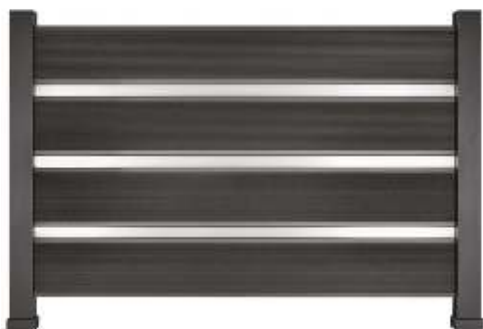

E-6493

Design con colonna 60x60mm, profilo 150x14mm e decorativo inox 30x11mm



C-6581

Design tradizionale con colonna 60x60mm e profilo verticale 100x14mm

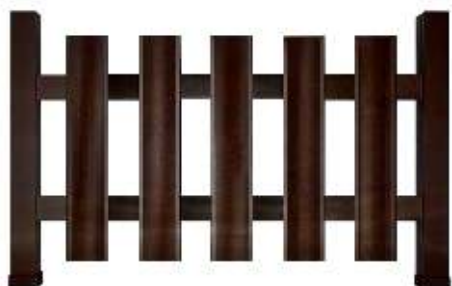

C-6581_A

Design tradizionale con colonna 60x60mm e profilo verticale disuguale 100x14mm



Accessori

DF-5003

Supporto a pavimento per colonna (22cm)



DF-5003D

Supporto a pavimento con base tonda piatta



DF-5036ASP

Cover per DF-5003D



DF-5003M

Supporto a pavimento per colonna (45cm)



DF-7002N

Flangia per colonna 40x40mm



DF-5003T

Supporto a pavimento con base quadrata piatta



DF-8002N

Flangia per colonna 60x60mm



AND
ANT
SAB
8017

DF-8009

Tappo terminale per colonna 100x14mm

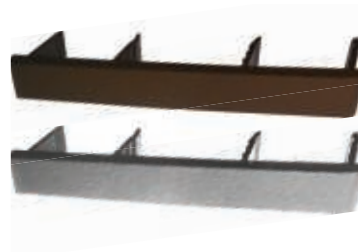

ANT
SAB
8017

DF-8013A

Tappo terminale per colonna 60x60mm

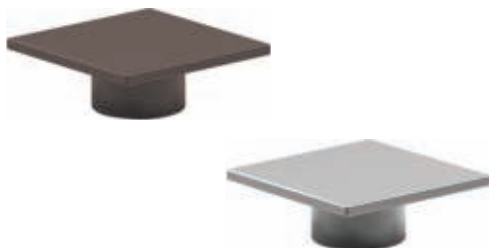

AND
ANT
SAB
8017

DF-7013S

Tappo terminale per colonna 40x40mm



DF-7036ASP

Cover decorativa per base 40x40mm



DF-7036L

Barra di supporto per colonna



Colonna

Assemblaggio colonna

Assemblaggio colonna DF-8005AN con cover/riduttore DF-8003 per profilo da 14mm

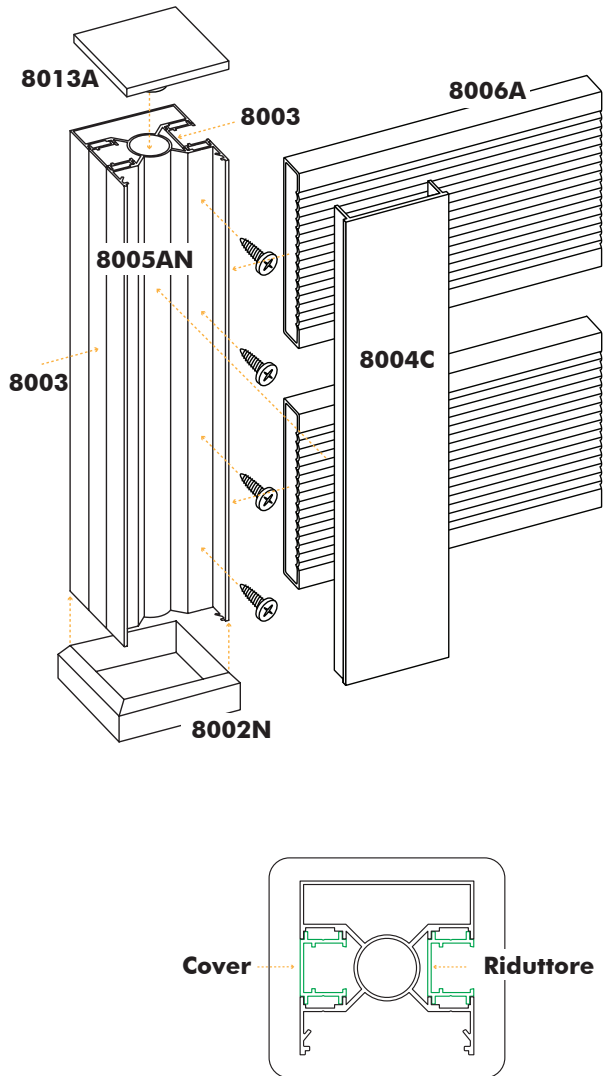

Assemblaggio colonna DF-8605N e installazione

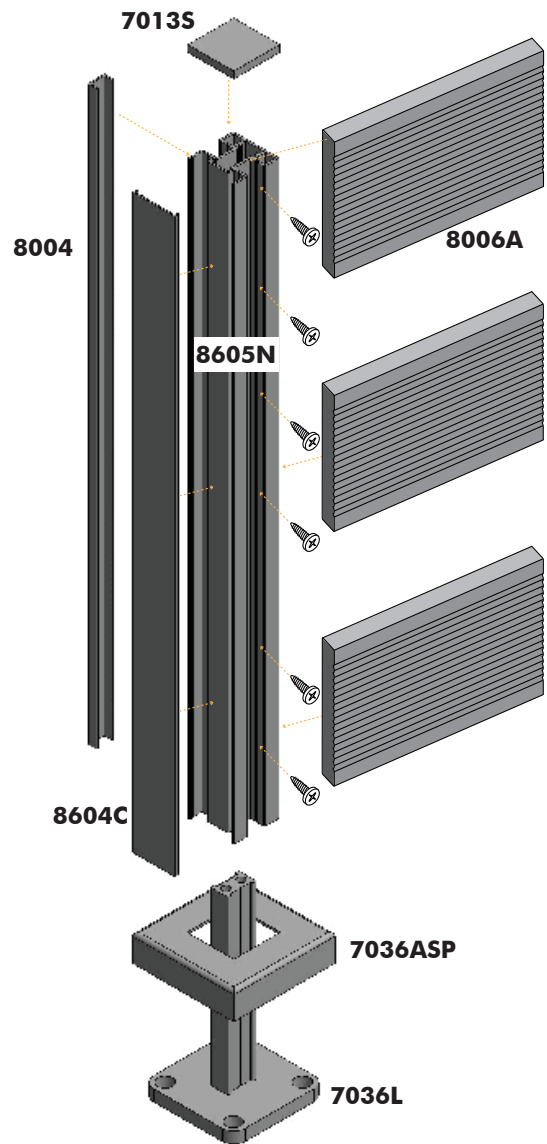

Colori standard



AND Anodizzato



ANT Antracite



SAB Sabbia



8017 Ral 8017



WCC Legno chiaro



WCM Legno medio



WCS Legno scuro