

# Accord BLADE

Linee parallele in una doppia colonna  
progettata per specifiche esigenze di design

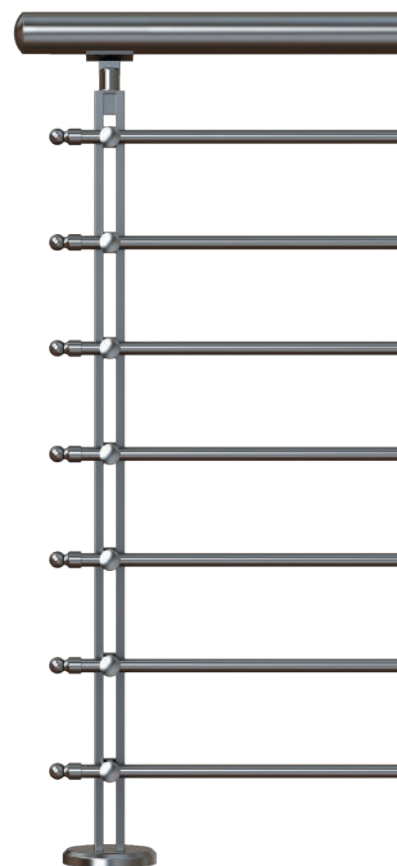

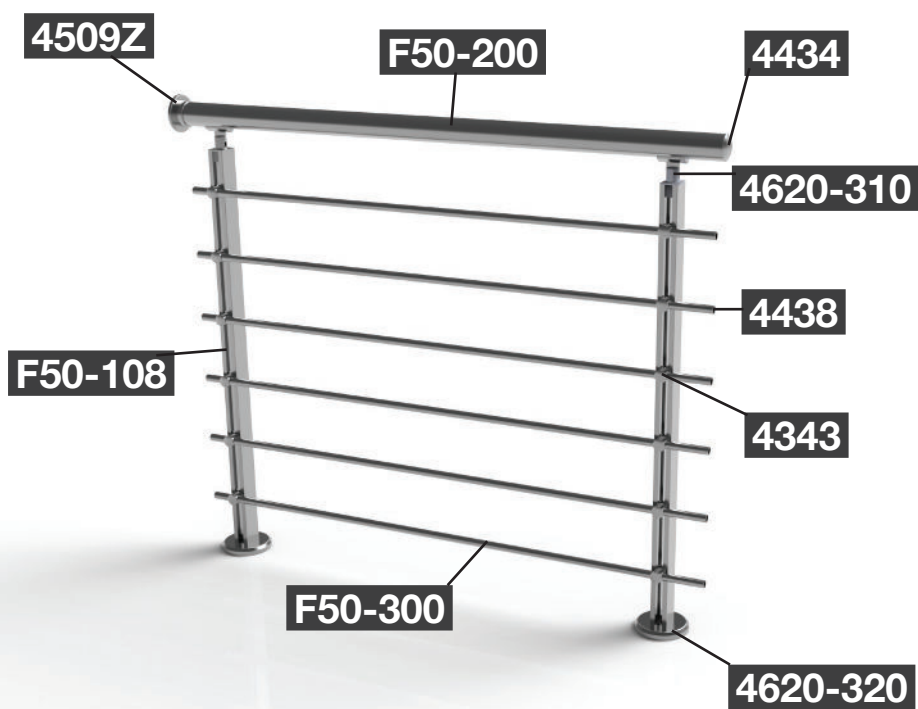

Colonna Blade  
Blade column

Codice / Code	<b>F50-108</b>
Lunghezza / Length	<b>5,8 m</b>

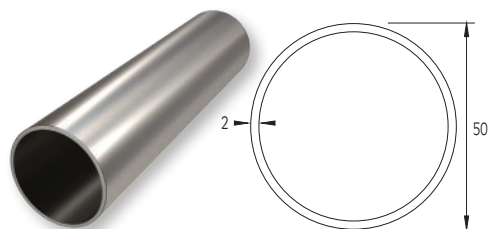

Corrimano Ø50  
Handrail Ø50

Codice / Code	<b>F50-200</b>
Lunghezza / Length	<b>5,8 m</b>

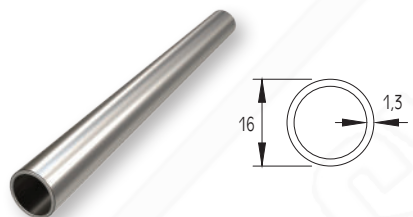

Profilo Ø16x1.3  
Profile Ø16X1.3

Codice / Code	<b>F50-300</b>
Lunghezza / Length	<b>5,8 m</b>



Profilo Ø16x3.5  
Profile Ø16X3.5

Codice / Code	<b>F50-301</b>
Lunghezza / Length	<b>5,8 m</b>

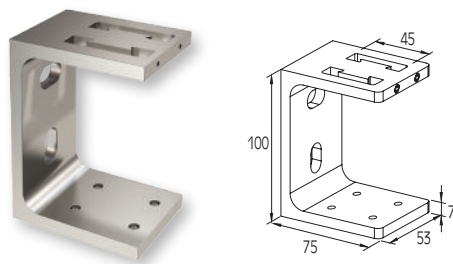

Supporto per fissaggio frontale per colonna BLADE  
External support for BLADE column

Codice / Code **4142**

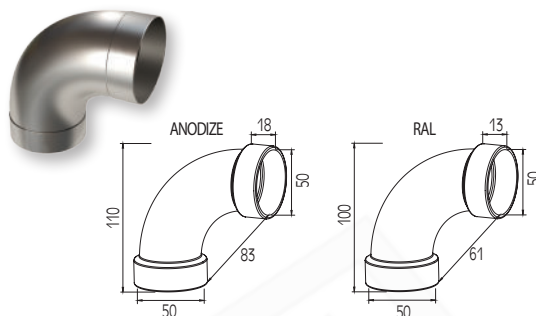

Connettore 90° per corrimano Ø50  
Connector 90° for handrail Ø50

Codice / Code **4219**

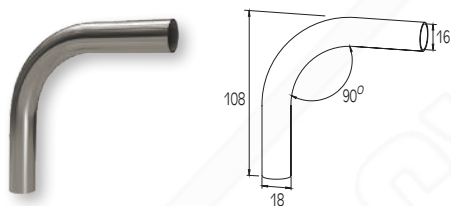

Connettore 90° per profilo Ø16  
Connector 90° for profile Ø16

Codice / Code **4228**

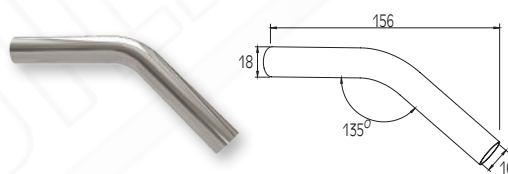

Connettore 135° per profilo Ø16  
Connector 135° for profile Ø16

Codice / Code **4229**

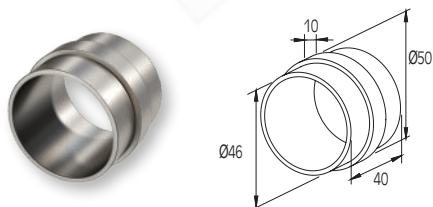

Connettore per corrimano Ø50 (interno)  
Connector for handrail Ø50 (internal)

Codice / Code **4241**

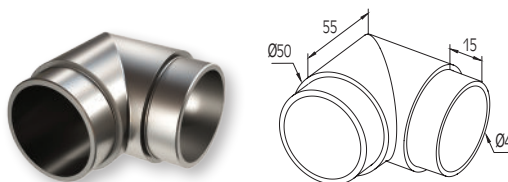

Connettore 90° per corrimano Ø50  
Connector 90° for handrail Ø50

Codice / Code **4256**

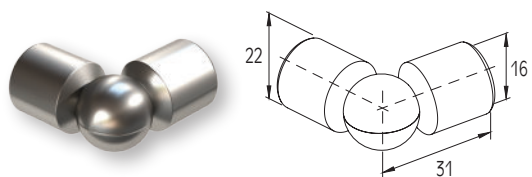

Connettore ad angolo regolabile per profilo Ø16  
Adjustable angle connector for profile Ø16

Codice / Code **4302**

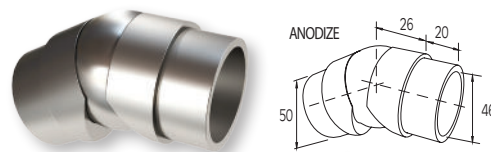

Connettore ad angolo regolabile per corrimano Ø50  
Adjustable corner connector for column Ø50

Codice / Code **4329**

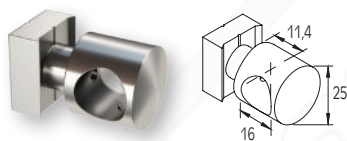

Connettore per profilo Ø16 con colonna BLADE  
Connector for profile Ø16 with BLADE column

Codice / Code **4343**

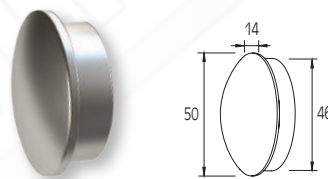

Coperchio per Corrimano F50-200  
End cap for F50-200 handrail

Codice / Code **4434**

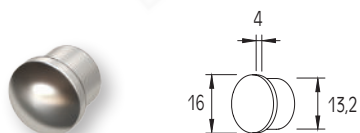

Coperchio per profilo F50-300  
End cap for F50-300 profile

Codice / Code **4438**

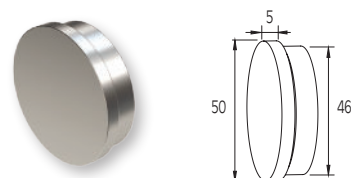

Coperchio per corrimano F50-200 (piatto)  
End cap for F50-200 handrail (flat)

Codice / Code **4453**

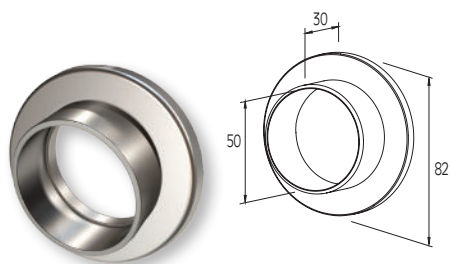

Fissaggio a parete per corrimano Ø50  
Wall cover for handrail Ø50

Codice / Code **4509Z**

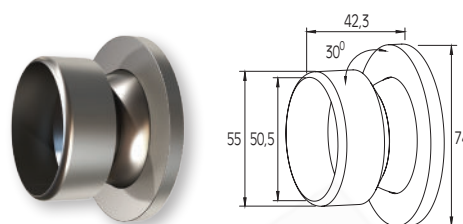

Cover orientabile a parete per corrimano Ø50  
Wall cover for handrail Ø50 with cap

Codice / Code **4518**

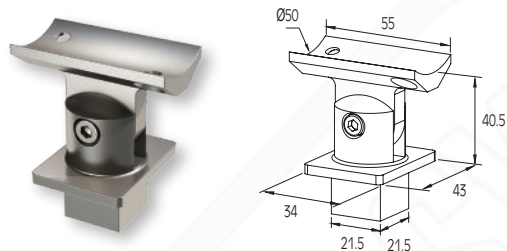

Connettore per corrimano Ø50 con colonna BLADE  
Support for handrail Ø50 - BLADE column

Codice / Code **4620-310**

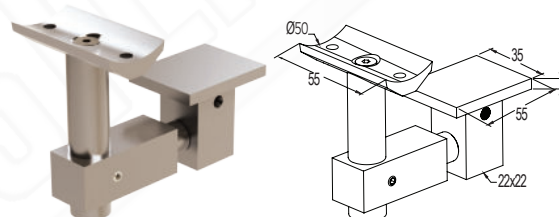

Supporto per corrimano Ø50 con colonna BLADE  
Support for handrail Ø50 - BLADE column

Codice / Code **4620-312**

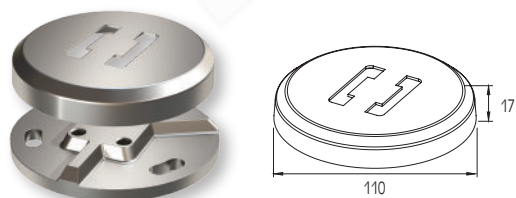

Piede di supporto per colonna F50-108  
F50-108 Column support foot

Codice / Code **4620-320**





- In proporzione 1:1
- Tempo di azione 7-8 minuti
- Tempo di inizio incollaggio 15-18 minuti
- Tempo di completo incollaggio 3-6 ore
  
- In proportion 1:1
- Working time 7-8 min
- Initial welding time 15-18 min
- Complete welding time 3-6 hours

Collante bicomponente 50 ml  
Glue 50 ml

Codice / Code **6K9450**



Beccuccio mixer per collante bicomponente  
Glue mixer accessory

Codice / Code **6KA100**



Pistola per applicazione colla bicomponente  
Glue application pistol

Codice / Code **6KA200**





