

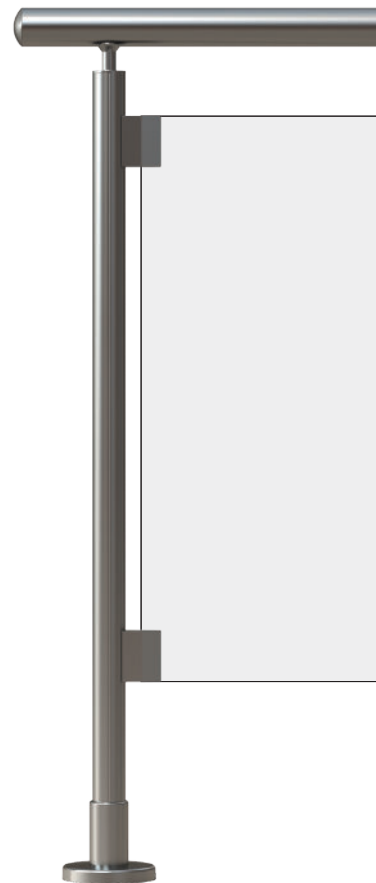

Horizon

Delicato, etereo e sottile.
Rilassati alla magnifica vista dell'orizzonte.
Lascia che la tua immaginazione sia libera da ogni ostacolo.

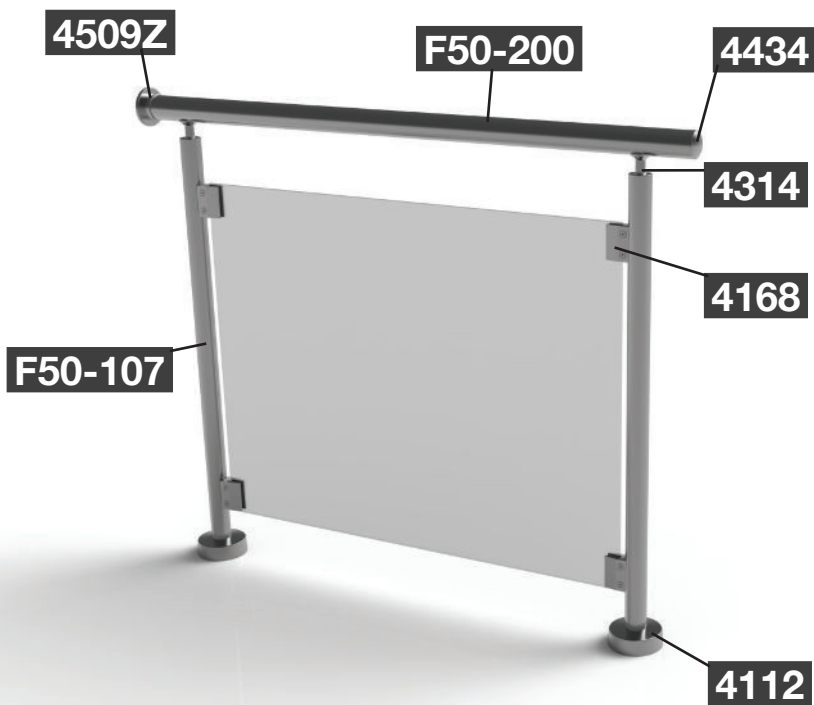

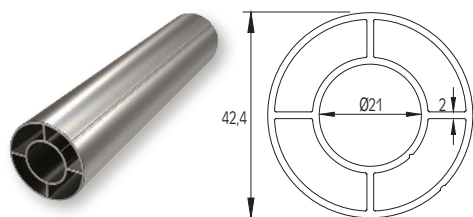

Colonna Ø42
Support column Ø42

Codice / Code **F50-100**

Lunghezza / Length **5,8 m**

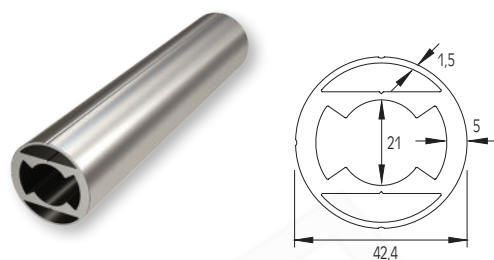

Colonna rinforzata Ø42
Reinforced column Ø42

Codice / Code **F50-107**

Lunghezza / Length **5,8 m**

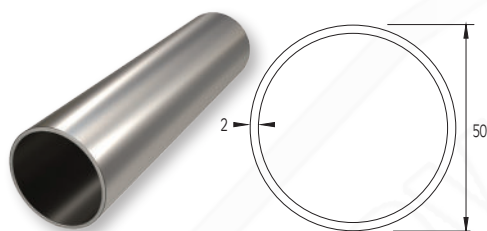

Corrimano Ø50
Handrail Ø50

Codice / Code **F50-200**

Lunghezza / Length **5,8 m**

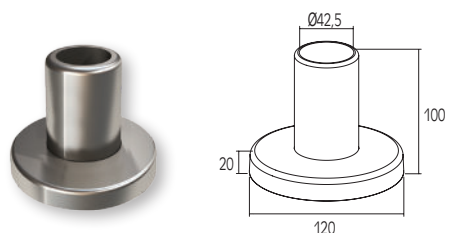

Piede per colonna Ø42
External support foot for Ø42 column

Codice / Code **4112**

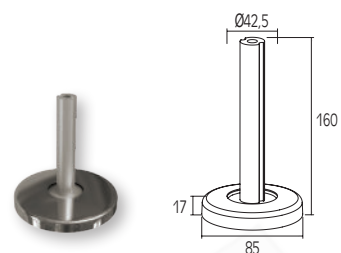

Piede per colonna Ø42
Support foot for Ø42 column

Codice / Code **4115**

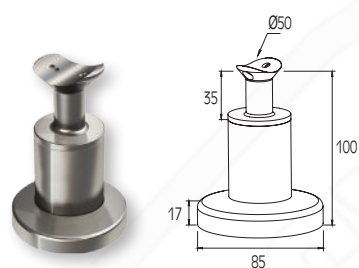

Supporto per Corrimano F50-200
Support for F50-200 railtop

Codice / Code **4116**

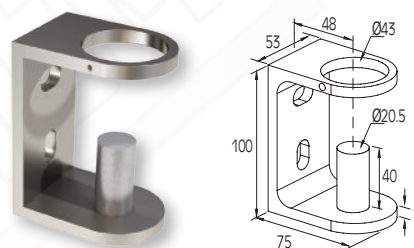

Supporto per fissaggio frontale per colonne F50-100
e F50-103
External support for F50-100/103 columns

Codice / Code **4143**

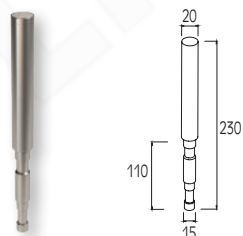

Supporto a pavimento per colonna F50-102
Infloor support for F50-102 column

Codice / Code **4188**



Supporto a pavimento per colonna F50-102 (400mm)
Infloor support for F50-102 column

Codice / Code **4188-A**

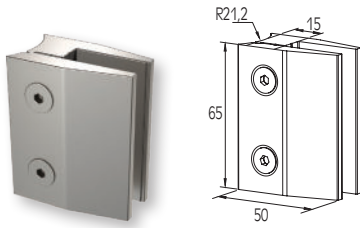

Supporto vetro 8-10 mm
Glass support 8-10 mm

Codice / Code **4168**

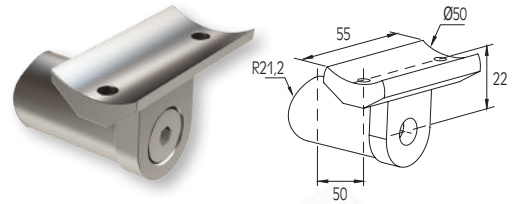

Supporto esterno per corrimano Ø50-colonna Ø42
External support for handrail Ø50-column Ø42

Codice / Code **4169B**

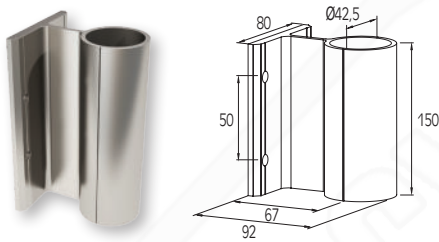

Supporto per fissaggio frontale per colonna Ø42
External support for column Ø42

Codice / Code **4194**

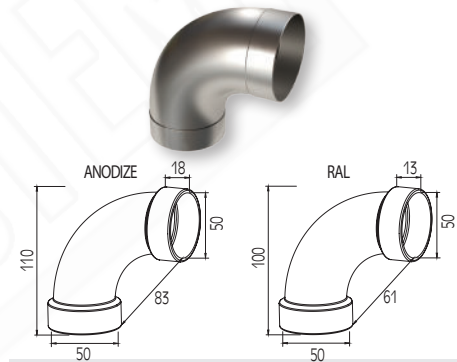

Connettore 90° per corrimano Ø50
Connector 90° for handrail Ø50

Codice / Code **4219**

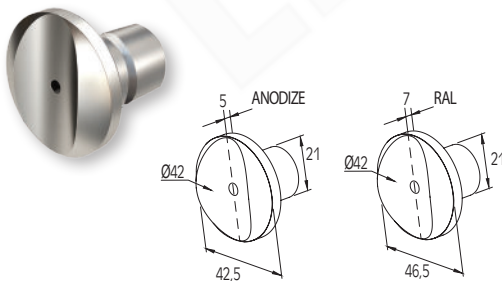

Connettore per colonna F50-100
con colonna F50-100
Connector for column with column F50-100

Codice / Code **4224**

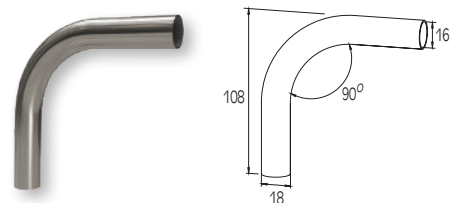

Connettore 90° per profilo Ø16
Connector 90° for profile Ø16

Codice / Code **4228**

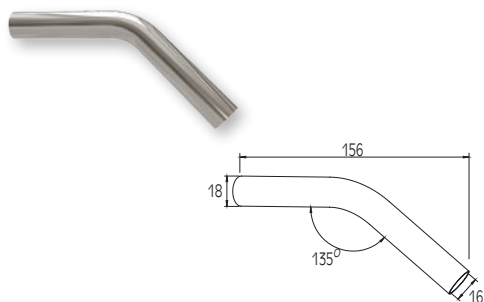

Connettore 135° per profilo Ø16
Connector 135° for profile Ø16

Codice / Code **4229**

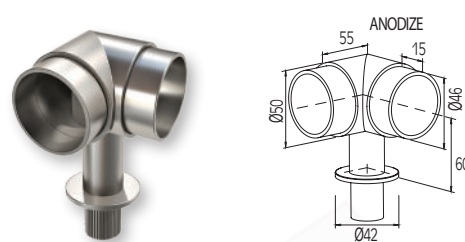

Raccordo angolo 90° per corrimano Ø50 con colonna F50-100
Connector 90° for handrail Ø50

Codice / Code **4231**

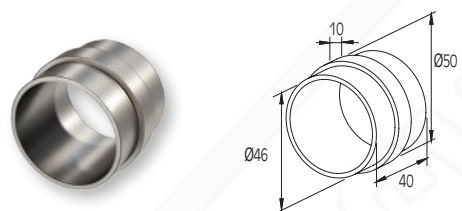

Connettore per corrimano Ø50 (interno)
Connector for handrail Ø50 (internal)

Codice / Code **4241**

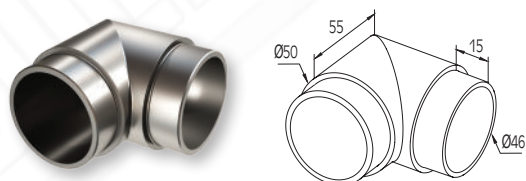

Connettore 90° per corrimano Ø50
Connector 90° for handrail Ø50

Codice / Code **4256**

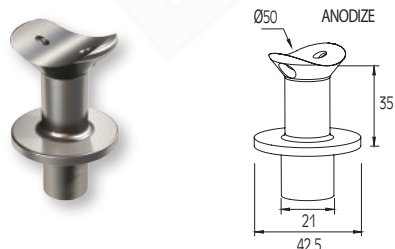

Connettore per corrimano Ø50 con colonna Ø42
Connector for handrail Ø50 with column Ø42

Codice / Code **4314**

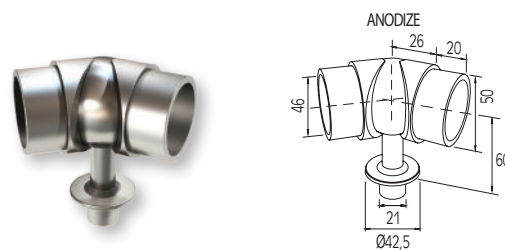

Connettore ad angolo regolabile per corrimano Ø50 con colonna Ø42
Adjustable corner Ø50 railtop connector

Codice / Code **4319**

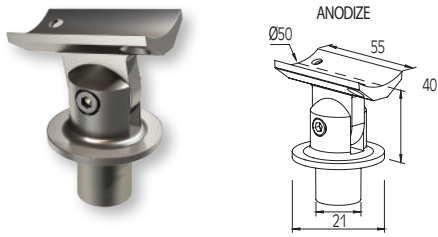

Connettore per corrimano Ø50 con colonna Ø42
(scale)
Connector for handrail Ø50 with column Ø42 (stairs)
Codice / Code **4316**

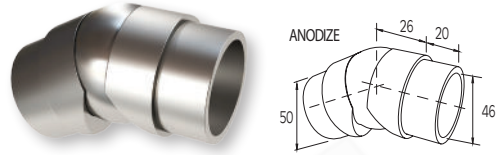

Connettore ad angolo regolabile per corrimano Ø50
Adjustable corner connector for column Ø50
Codice / Code **4329**

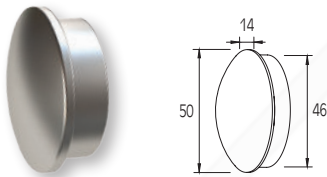

Coperchio per Corrimano F50-200
End cap for F50-200 handrail
Codice / Code **4434**

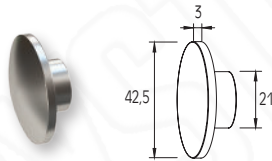

Coperchio per colonna F50-100
End cap for F50-100 column
Codice / Code **4436**

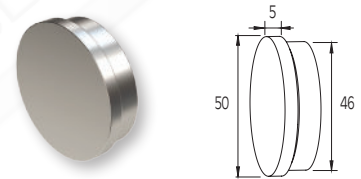

Coperchio per corrimano F50-200
(piatto)
End cap for F50-200 handrail (flat)
Codice / Code **4453**

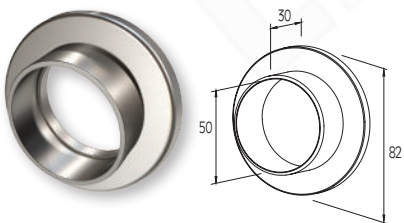

Fissaggio a parete per corrimano Ø50
Wall cover for handrail Ø50
Codice / Code **4509Z**

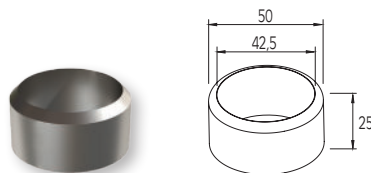

Cover a pavimento per colonna Ø42
Wall cover for column Ø42
Codice / Code **4510**

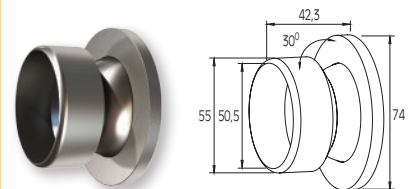

Cover a parete orientabile per corrimano
Ø50
Wall cover for handrail Ø50
Codice / Code **4518**



- In proporzione 1:1
- Tempo di azione 7-8 minuti
- Tempo di inizio incollaggio 15-18 minuti
- Tempo di completo incollaggio 3-6 ore

- In proportion 1:1
- Working time 7-8 min
- Initial welding time 15-18 min
- Complete welding time 3-6 hours

Collante bicomponente 50 ml
Glue 50 ml

Codice / Code **6K9450**



Beccuccio mixer per collante bicomponente
Glue mixer accessory

Codice / Code **6KA100**



Pistola per applicazione colla bicomponente
Glue application pistol

Codice / Code **6KA200**

