

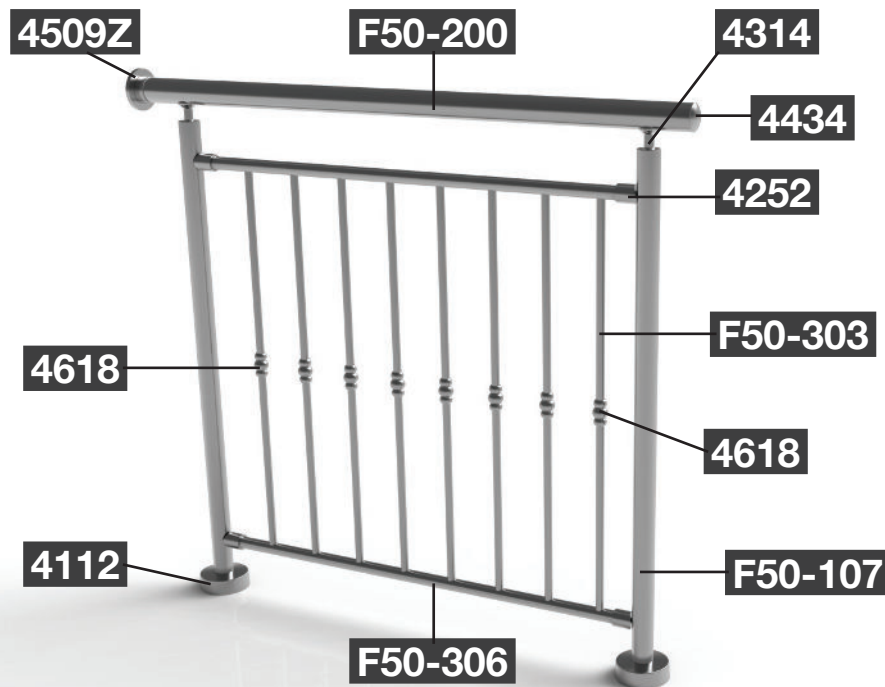

Vertical R

Una soluzione alternativa per gli amanti del design classico. Lusso delicato e linee raffinate.



Installazione F50-306

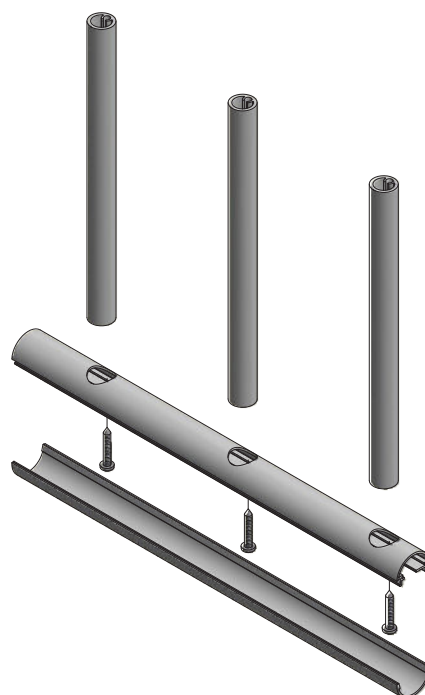
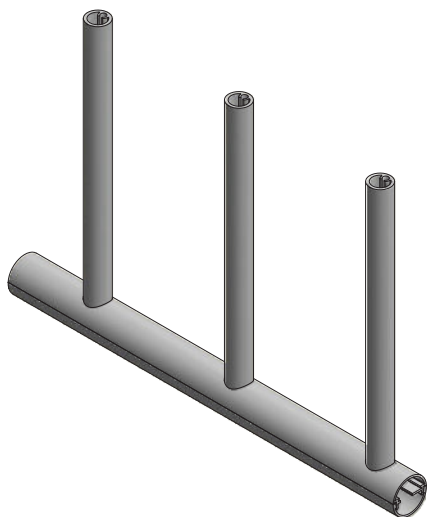

F50-306P

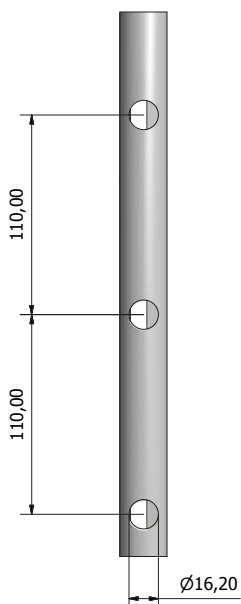

Vista sezione laterale

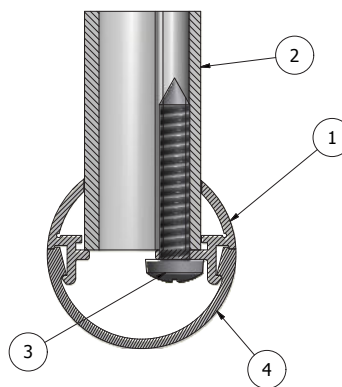

- 1. n° 1 pz. - F50-306P
- 2. n° 3 pz. - F50-303
- 3. n° 3 pz. - Vite autofilettante
ST4,2 x 25 - C - H
- 4. n° 1 pz. - F50-306K

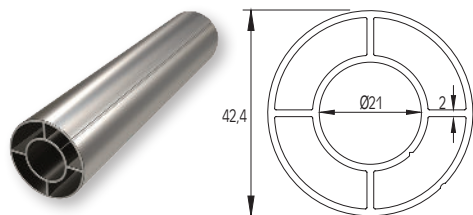

Colonna Ø42
Support column Ø42

Codice / Code	F50-100
Lunghezza / Length	5,8 m

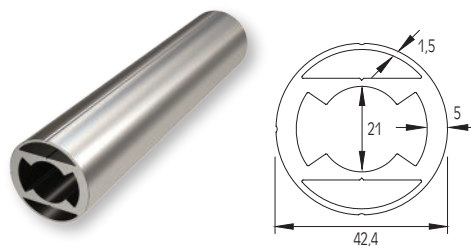

Colonna rinforzata Ø42
Reinforced column Ø42

Codice / Code	F50-107
Lunghezza / Length	5,8 m

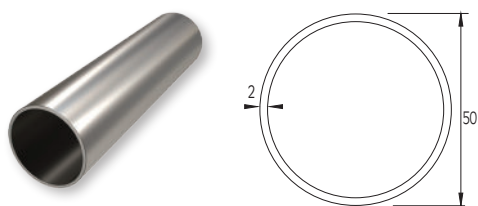

Corrimano Ø50
Handrail Ø50

Codice / Code	F50-200
Lunghezza / Length	5,8 m

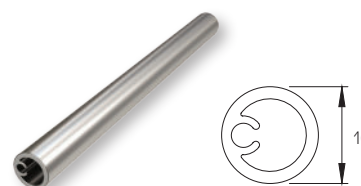

Profilo Ø16 con foro vite
Profile Ø16 with screw hole

Codice / Code	F50-303
Lunghezza / Length	5,8 m

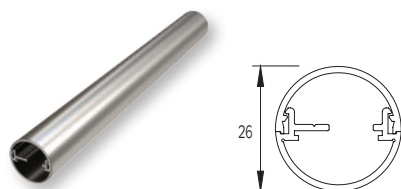

Guida perforata Ø26 per profilo F50-303
Perforated guide Ø26

Codice / Code	F50-306
Lunghezza / Length	5,8 m

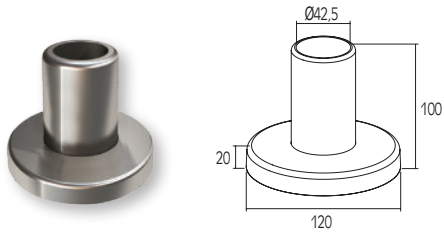

Piede per colonna Ø42
External support foot for Ø42 column

Codice / Code **4112**

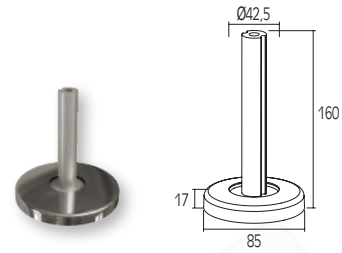

Piede per colonna Ø42
Support foot for Ø42 column

Codice / Code **4115**

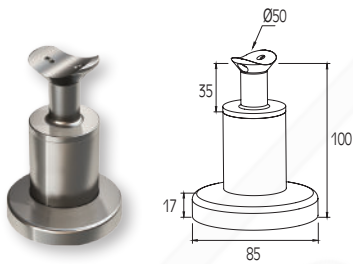

Supporto per Corrimano F50-200
Support for F50-200 railtop

Codice / Code **4116**

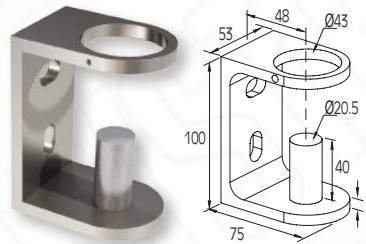

Supporto per fissaggio frontale per
colonne F50-100 / 103
External support for F50-100/103
columns

Codice / Code **4143**

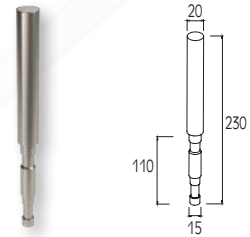

Supporto a pavimento per colonna
F50-102
Infloor support for F50-102 column

Codice / Code **4188**



Supporto a pavimento per colonna F50-
102 (400mm)
Infloor support for F50-102 column

Codice / Code **4188-A**

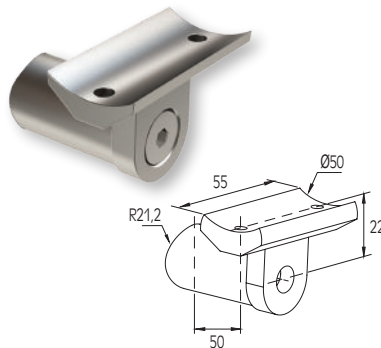

Supporto esterno per corrimano
Ø50-colonna Ø42
External support for handrail
Ø50-column Ø42

Codice / Code **4169B**

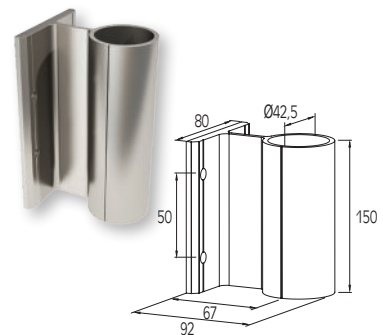

Supporto per fissaggio frontale per
colonna Ø42
External support for column Ø42

Codice / Code **4194**

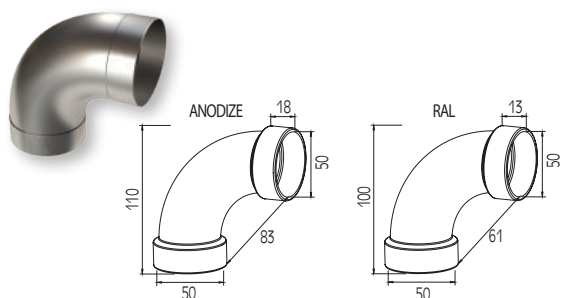

Connettore 90° per corrimano Ø50
Connector 90° for handrail Ø50

Codice / Code **4219**

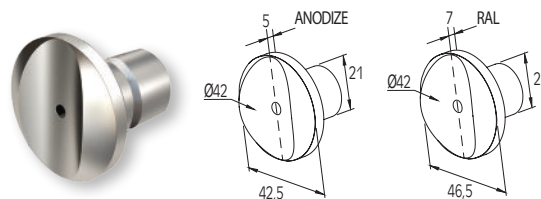

Connettore per colonna F50-100 con colonna
F50-100
Connector for column F50-100 with column F50-100

Codice / Code **4224**

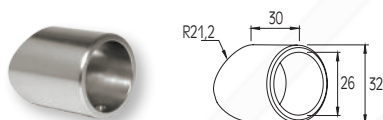

Connettore per colonna F50-100 con profilo Ø26
Connector for F50-100 column with profile Ø26

Codice / Code **4225**

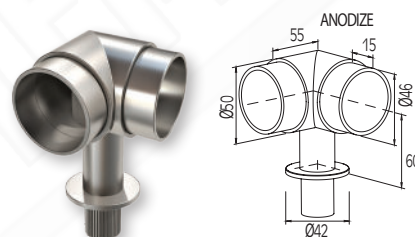

Raccordo angolo 90° per corrimano Ø50 con colonna
F50-100
Connector 90° for handrail Ø50

Codice / Code **4231**

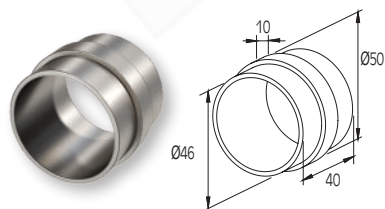

Connettore per corrimano Ø50 (interno)
Connector for handrail Ø50 (internal)

Codice / Code **4241**

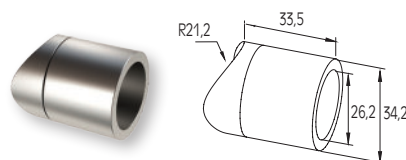

Connettore per colonna F50-100 con profilo Ø26
Connector for F50-100 Column with profile Ø26

Codice / Code **4252**

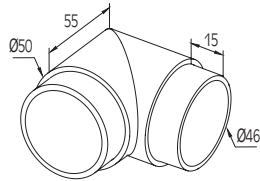

Connettore 90° per corrimano Ø50
Connector 90° for handrail Ø50

Codice / Code **4256**

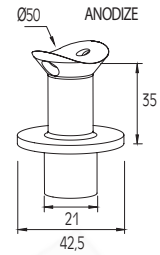

Connettore per corrimano Ø50 con colonna Ø42
Connector for handrail Ø50 with column Ø42

Codice / Code **4314**

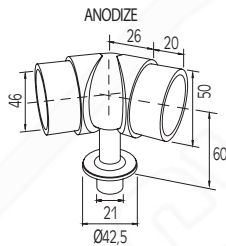

Connettore ad angolo regolabile per corrimano Ø50
con colonna Ø42
Adjustable corner connector
for column Ø42

Codice / Code **4319**

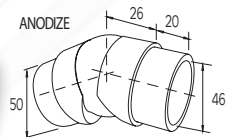

Connettore ad angolo regolabile per corrimano Ø50
Adjustable corner connector for column Ø50

Codice / Code **4329**

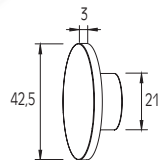

Coperchio per colonna F50-100
End cap for F50-100 column

Codice / Code **4436**

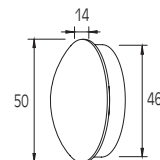

Coperchio per Corrimano F50-200
End cap for F50-200 handrail

Codice / Code **4434**

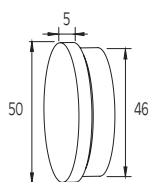

Coperchio per corrimano F50-200 (piatto)
End cap for F50-200 handrail (flat)

Codice / Code **4453**

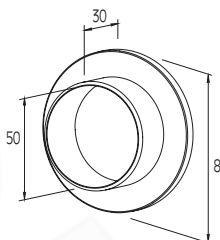

Fissaggio a parete per corrimano Ø50
Wall cover for handrail Ø50 with cap

Codice / Code **4509Z**

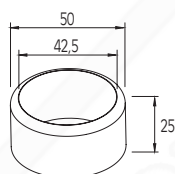

Cover a pavimento per colonna Ø42
Wall cover for column Ø42

Codice / Code **4510**

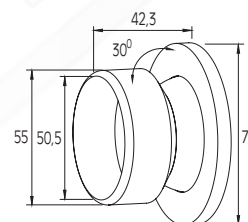

Cover a parete orientabile per corrimano Ø50
Wall cover for handrail Ø50 with cap

Codice / Code **4518**

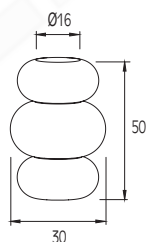

Borchia per profilo Ø16
Glass rosette for profile Ø16

Codice / Code **4618**



- In proporzione 1:1
- Tempo di azione 7-8 minuti
- Tempo di inizio incollaggio 15-18 minuti
- Tempo di completo incollaggio 3-6 ore

- In proportion 1:1
- Working time 7-8 min
- Initial welding time 15-18 min
- Complete welding time 3-6 hours

Collante bicomponente 50 ml
Glue 50 ml

Codice / Code **6K9450**



Beccuccio mixer per collante bicomponente
Glue mixer accessory

Codice / Code **6KA100**



Pistola per applicazione colla bicomponente
Glue application pistol

Codice / Code **6KA200**



